

For standby power supplies  
 Expected trickle life: 6 years at 25°C  
 10 years at 20°C

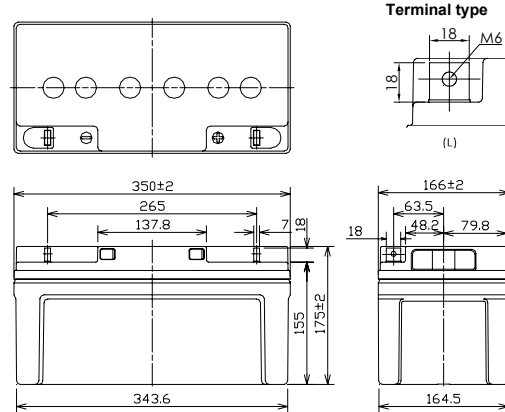

### ■ Dimensions(mm)



Battery case resin: Flame-retardant (UL94V-0)

※Contents indicated (including the recycle marking,etc) are subject to change without notice.

### ■ Specifications

Nominal Voltage		12V
Rated Capacity(20HR)		75Ah
Dimensions	Length	350 mm
	Width	166 mm
	Height	175 mm
	Total height	175 mm
Approx. Mass		21.5 kg
Terminal		M6 threaded post

### ■ Characteristics

Capacity (25 °C)	20 hour rate	75Ah
	10 hour rate	70Ah
	3 hour rate	53Ah
	1 hour rate	50Ah
Internal Resistance (25 °C)	Fully charged battery	7 mΩ
Temperature Dependency of Capacity (20 hour rate)	40 °C	102%
	25 °C	100%
	0 °C	85%
	-15 °C	65%
Self Discharge (25 °C)	After 3 months	91%
	After 6 months	82%
	After 12 months	64%

### ■ Duration of discharge vs. discharge current

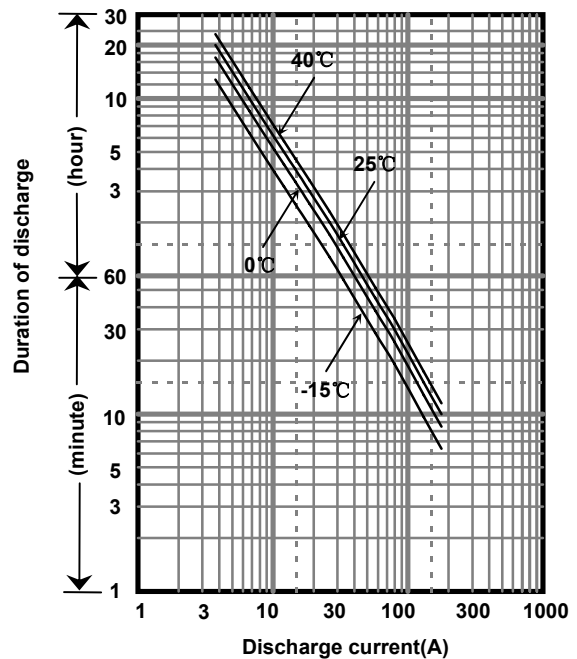

### ■ Watt Table(25°C)

Wattge values in the table are average instead of guaranteed value, please consider appropriate redundancy by application.

(Wattage/Battery)

Cut-off V	5min	10min	15min	20min	30min	45min	1h	1.5h	2h	3h	4h	5h	6h	10h	20h
9.6V	2273	1985	1546	1313	962	702	555	411	327	220	171	149	125	79.5	45.0
9.9V	2233	1950	1538	1306	955	683	553	403	325	216	169	147	124	79.1	45.0
10.2V	2093	1827	1531	1290	940	679	549	400	321	215	168	146	123	78.6	45.0
10.5V	1875	1637	1446	1230	925	671	546	395	317	210	166	144	122	78.2	45.0
10.8V	1657	1447	1400	1200	911	580	473	355	301	205	164	143	120	77.8	44.1

### ■ Ampere Table(25°C)

Ampere values in the table are average instead of guaranteed value, please consider appropriate redundancy by application.

(Ampere/Battery)

Cut-off V	5min	10min	15min	20min	30min	45min	1h	1.5h	2h	3h	4h	5h	6h	10h	20h
9.6V	241	177	134	116	86.9	61.5	51.0	34.8	27.6	18.5	14.3	12.4	10.4	7.14	3.75
9.9V	237	175	132	113	86.3	59.9	50.8	34.1	27.4	18.2	14.2	12.2	10.3	7.11	3.75
10.2V	222	167	130	111	84.9	59.5	50.5	33.8	27.1	18.1	14.0	12.1	10.2	7.07	3.75
10.5V	199	159	126	109	83.6	58.9	50.2	33.4	26.8	17.7	13.9	12.0	10.1	7.04	3.75
10.8V	176	151	122	106	82.3	50.8	43.5	30.1	25.4	17.3	13.7	11.9	10.0	7.00	3.68

### Charging Method (25°C)

Trickle use	Control voltage:13.6-13.8V Initial current:11.3A or smaller
-------------	--

### Cut off voltage

Discharge current	3.75A-15.0A	15.0A-37.5A	37.5A-75.0A	75.0A-150A	150A-225A
Cut off voltage(V)	10.5	10.2	9.9	9.3	8.7

### Influence of Temperature on Trickle life

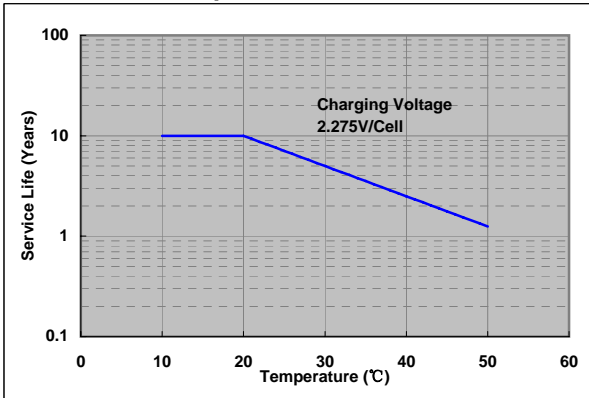

### Residual capacity test result

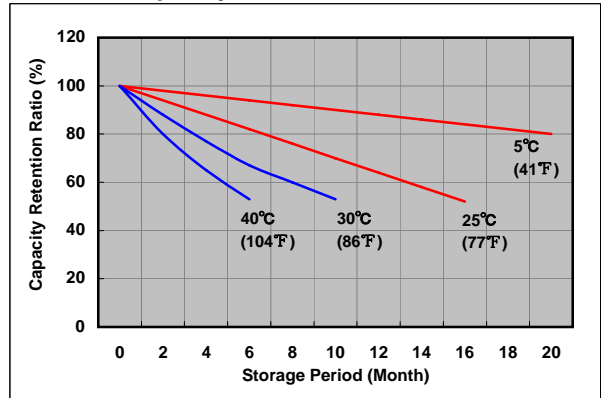

### Constant-voltage constant-current charge characteristics for Trickle use

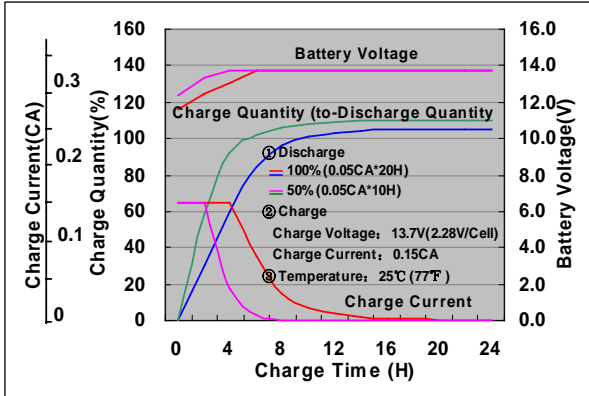

### Discharge capacity by temperature and by discharge current

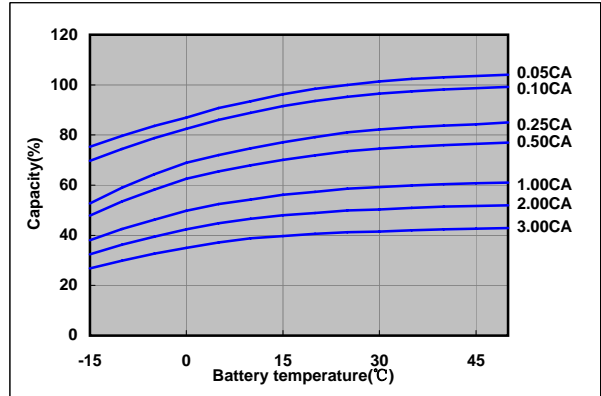

### Discharge characteristics(25°C)

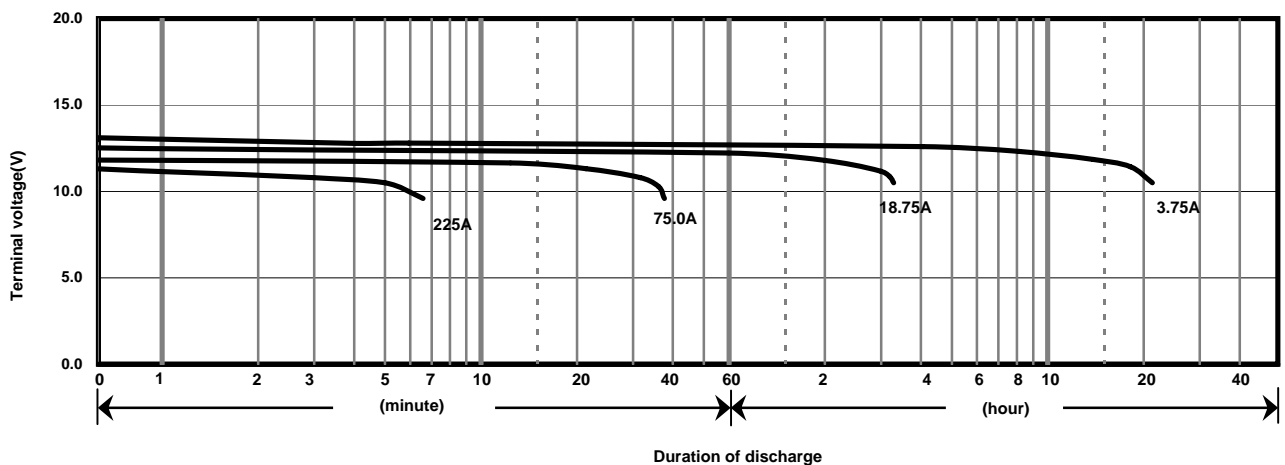

### Caution

Due to the potential energy stored in the batteries, Please read 《Precautions for handling the Rechargeable Valve Regulated Lead Acid Batteries》 before using batteries. If improper handling or use of the batteries without understanding 《Precautions for handling the Rechargeable Valve Regulated Lead Acid Batteries》 may result in bodily injury caused by electrolyte leakage, heat generation, or explosion.

## Panasonic Storage Battery (Shenyang) Co., Ltd

NO. 17 Hunhe 20Th Street, Shenyang Economic & Technical Development Zone, 110142 China

Tel: 86 24 25818921

Fax: 86 24 62786318

Website: <http://www.panasonicbattery.cn>

2016.01